



Technical Standards and Safety Authority  
 345 Carlingview Drive  
 Toronto, Ontario M9W 6N9  
 www.tssa.org

Show facsimile of manufacturer's logo or trademark, as it will appear on the fitting, in the space below

Swagelok

## STATUTORY DECLARATION Registration of Fittings

I, Joel Feldman, Vice President of Engineering  
(Name and Position, e.g. President, Plant Manager, Chief Engineer)

of Swagelok Company  
(Name of Manufacturer)

Located at 29500 Solon Road, Solon, Ohio 44139 USA (440) 248-4600 (440) 349-5970  
(Plant Address) (Telephone No.) (Fax No.)

do solemnly declare that the fittings listed hereunder, which are subject to the **Technical Standards and Safety Act**, Boilers and Pressure Vessels Regulation, comply with all of the requirements of ASME B31.1 for unlisted components, and ASME B31.3 for unlisted components  
(Title of recognized North American Standard)  
 which specifies the dimensions, materials of construction, pressure/temperature ratings, identification marking the fittings and service;

or are not covered by the provisions of a recognized North American standard and are therefore manufactured to comply with \_\_\_\_\_ as supported by the attached data which identifies the dimensions, material of construction, pressure/temperature ratings and the basis for such ratings, the marking of the fitting for identification and service.

I further declare that the manufacture of these fittings is controlled by a quality system meeting the requirements of ISO 9001:2015 which has been verified by the following authority, BSI

The items covered by this declaration, for which I seek registration, are category A. Fittings type fittings. In support of this application, the following information and/or test data are attached as follows:  
ISO 9001:2015 Certificate, Attachment A, Attachment B, Catalog Information and other Support Documents  
(drawings, calculations, test reports, etc.)

Declared before me at Solon in the State of Ohio  
 the 29th day of November AD 2018.

Commissioner for Oaths:  
Jamie L Ristau Jamie L Ristau  
(Printed name) Resident Portage County  
 Notary Public, State of Ohio  
 My Commission Expires: 03/06/2019  
Jamie L Ristau  
(Signature)

Joel C. Feldman  
(Signature of Declarer)

### FOR OFFICE USE ONLY

To the best of my knowledge and belief, the application meets the requirements of the **Technical Standards and Safety Act**, Boilers and Pressure Vessels Regulation, and CSA Standard B51 and is accepted for registration in Category A.

CRN: 0A21025.5

Registered by: Amir Hariri

Dated: 24 Jan 2019

NOTE: This registration expires on: 24 Jan 2029

OFFICE  
REGISTERED

CRN: 0A21025.5

Signed: [Signature]

24 Jan 2019

For scope of Registration see Attachments A & B.  
 AH

## Attachment B. Scope of Registration for Swagelok Stainless Steel Tube Fittings (Category A)

### Product Scope

This document represents the scope of Swagelok Stainless Steel Tube Fittings covered by this submission for CRN approval. These Swagelok Tube Fittings have been evaluated in accordance with ASME B31.3-2016 for unlisted components and ASME B31.1-2016 for unlisted components.

### Summary Table

Product Description or Series	Material (Standard)	Port Connections and Sizes	Maximum Allowable Working Pressure		Design Code of Construction	
			Up to 100°F	At maximum temperature		
Gaugeable Tube Fittings and Adapter Fittings	316 SS (ASTM A479) For straight fittings, hardware  F316 SS (ASTM A182) For shaped fittings	Swagelok End Connection 1/16 - 2 inch (Fractional) 3mm - 50 mm (Metric)	See Table on Page 2	See Table on Page 2	ASME B31.3 (Unlisted Components)  ASME B31.1 (Unlisted Components)	
		NPT Male 1/16 - 2 inch	11000 - 3900 psig	6160-2184 psig** @1000°F (537°C)	Based on ASME B1.20.1 listed in Table 326.1 of B31.3 and Table 126.1 of B31.1	
		NPT Female 1/16 - 2 inch	6700 - 3900 psig	3752-2184 psig** @1000°F (537°C)		
		ISO/BSP (parallel) - PR Male 1/8 - 1 inch	4568 - 2320 psig* (low limit 15°F)	4568 - 2320 psig @150°F (65°C)	ASME B31.3 (Unlisted Components)	
		ISO/BSP (parallel) - RP Male 1/8 - 1/2 inch	6700-2400 psig with copper gasket*	6700 - 2400 psig @400°F (204°C) with copper gasket*		
		ISO/BSP (parallel) RS Male 1/8-1 inch	6500-2700 psig with FKM bonded gasket* (limit -20°F)	6500-2700 psig @400°F (204°C) with FKM bonded gasket*		
		ISO/BSP (parallel) RG Female 1/4 - 1/2 inch	4036 psig with copper gasket*	4036 psig @400°F (204°C) with copper gasket*		
		ISO-7 (tapered)(RT) Male 1/8 - 2 inch	11000 - 3900 psig	6160-2184 psig** @1000°F (537°C)		ASME B31.1 (Unlisted Components)
		ISO-7 (tapered)(RT) Female 1/8 - 2 inch	6700 - 3900 psig	3752-2184 psig** @1000°F (537°C)		
		UN / UNF(SAE) Stud (ST) Male 1/8 - 2 inch	4568 - 1813 psig*	4568 - 1813 psig @400°F (204°C)		ASME B31.1 (Unlisted Components)
		UN / UNF (SAE) Pos. (ST) Male 1/8 - 2 inch	4568 - 1450 psig*	4568 - 1450 psig @400°F (204°C)		
		Tube Socket Weld 1/8 - 1 inch	12500 - 5600 psig	7000 - 3136 psig @1000°F (537°C)		
		Male Pipe Weld 1/4 - 1 inch	10300 - 6000 psig	5768-3360 psig @1000°F (537°C)		ASME B36.10M
		Unified (UNJ) (AN) Male Straight 1/8 - 1 inch	10000 - 5000 psig	5650-2825 psig @1000°F (537°C)		
		Unified (UNJ) (AN) Male Shape 1/8 - 1 inch	10000 - 4100 psig	5650-2316 psig @1000°F (537°C)		
		Unified (UNJ) (AN) Female w/ Swivel Nut 1/8 - 1 inch	4500 - 2500 psig	2542-1412 psig @1000°F (537°C)		

\* Temperature rating is gasket, or O-ring material dependent

\*\*Rating for fitting material (may be limited by thread sealant)

THIS IS PART OF  
 CRN 0121025-5  
 Technical Standards & Safety Authority  
 Boilers & Pressure Vessels  
 Safety Program



**Stainless Steel Swagelok Tube Fitting Pressure Rating Table**

Swagelok End Connection Size	Maximum Allowable Working Pressure (1)	
	Up to 100°F	At maximum temperature 1000°F (537°C)
1/16 inch	12 000 psig	9 120 psig
1/8 inch	10 900 psig	8 284 psig
3/16 inch	10 200 psig	7 752 psig
1/4 inch	10 200 psig	7 752 psig
5/16 inch	8 000 psig	6 080 psig
3/8 inch	7 500 psig	5 700 psig
1/2 inch	6 700 psig	5 092 psig
5/8 inch	6 000 psig	4 560 psig
3/4 inch	5 800 psig	4 408 psig
7/8 inch	4 800 psig	3 648 psig
1 inch	4 700 psig	3 572 psig
1 1/4 inch	4 800 psig	3 648 psig
1 1/2 inch	4 900 psig	3 724 psig
2 inch	3 600 psig	2 736 psig
3 mm	670 bar	509 bar
6 mm	710 bar	540 bar
8 mm	520 bar	395 bar
10 mm	580 bar	441 bar
12 mm	470 bar	357 bar
14 mm	430 bar	327 bar
15 mm	400 bar	304 bar
16 mm	400 bar	304 bar
18 mm	370 bar	281 bar
20 mm	380 bar	289 bar
22 mm	340 bar	258 bar
25 mm	320 bar	243 bar
28 mm	330 bar	251 bar
30 mm	310 bar	236 bar
32 mm	330 bar	251 bar
38 mm	310 bar	236 bar
50 mm	270 bar	205 bar

**Note (1):** Values based on thickest wall tubing and stress values per ASME B31.3. Thinner tubing may be used but in all cases the ratings are less than, or equal to, those shown in the table.

THIS IS PART OF  
 CRN 0A2025-5  
 Technical Specification  
 Edition 1.0



## Product Description

Swagelok Fittings are furnished in a variety of configurations and shapes (straight, elbow, tee or cross). Swagelok Fittings consist of at least one Swagelok End – a two-ferrule mechanical-grip design. The Swagelok end is a proprietary design, and the assembly consists of Swagelok body, nut, front and back ferrule (see detail). The table above, as well as the “Configurations” section, covers a variety of other end connections.

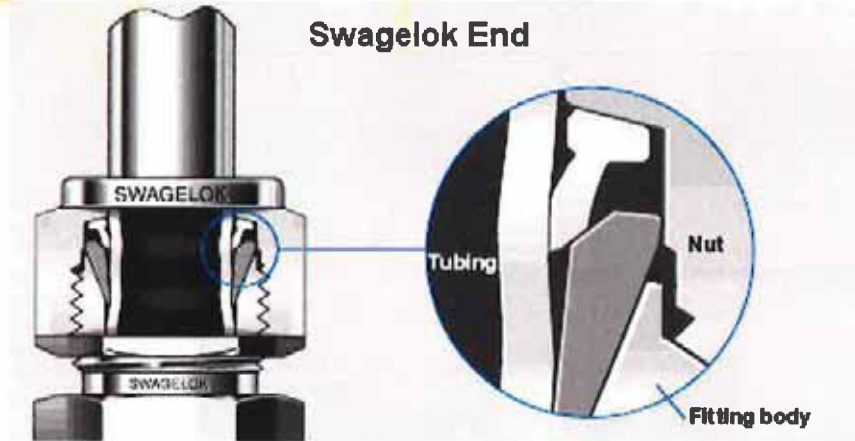

THIS IS PART OF  
0A21025-5

## Configurations

### 1. Unions.

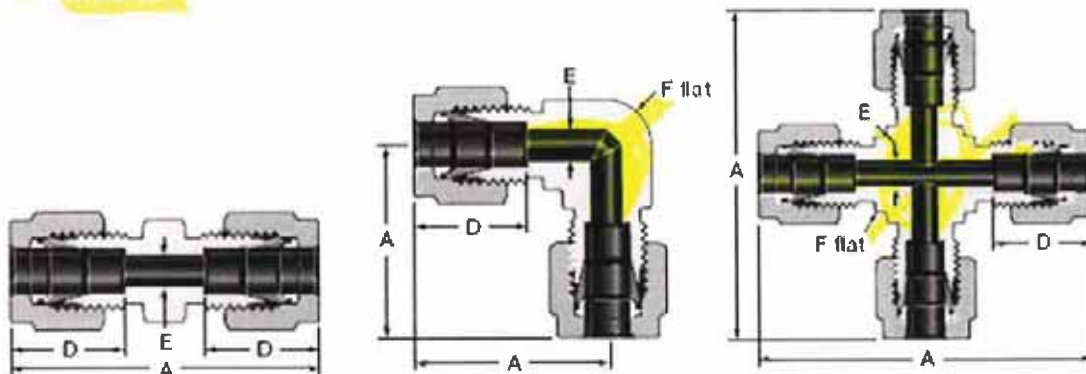

### 2. Male and Female connectors / adapters.

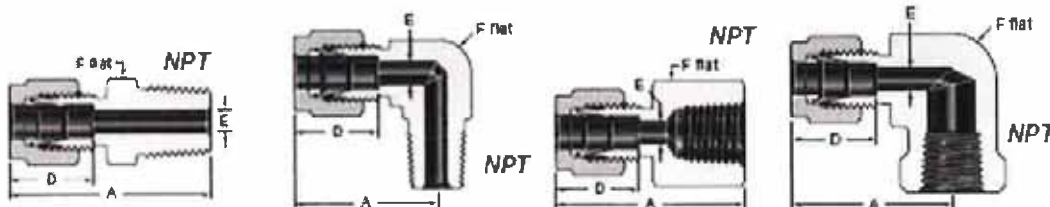

**NPT Male Connectors**

**Female Connectors**

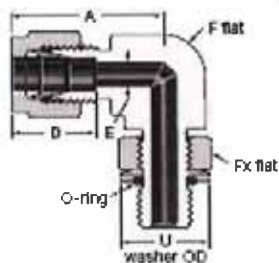

**Positionable, ISO/BSP Parallel Thread (PR)**

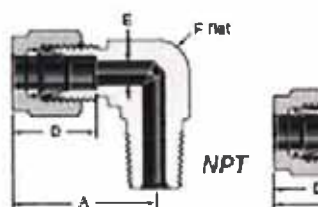

**ISO/BSP Parallel Thread (RP)**

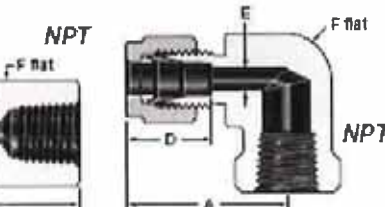

**ISO/BSP Parallel Thread (RS)**

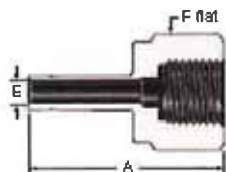

**ISO/BSP Parallel Thread (RG, Gauge)**

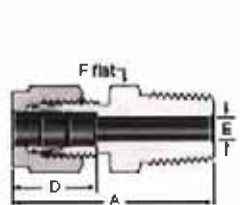

**ISO/BSP Tapered Thread (RT)**

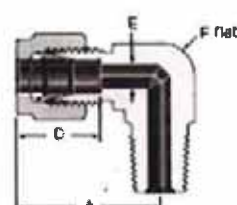

**ISO/BSP Tapered Thread (RT)**

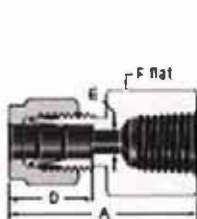

**ISO/BSP Tapered Female Thread (RT)**

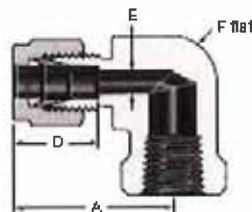

**ISO/BSP Tapered Female Thread (RT)**

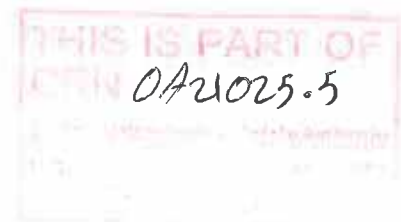

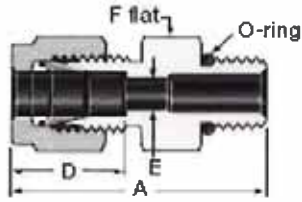

**SAE/MS Straight Thread Stud (ST)**

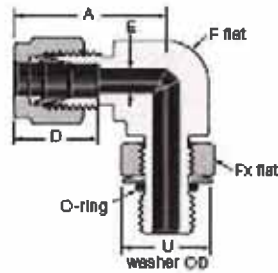

**Positionable SAE/MS Straight Thread (ST)**

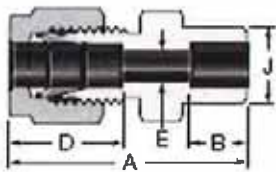

**Tube Socket Weld**

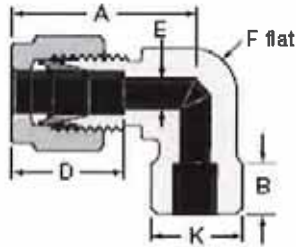

**Tube Socket Weld**

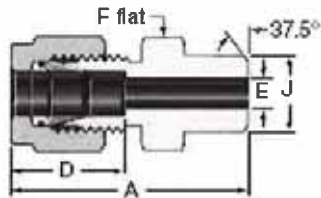

**Male Pipe Weld**

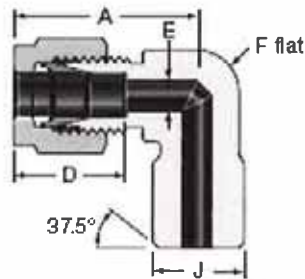

**Male Pipe Weld**

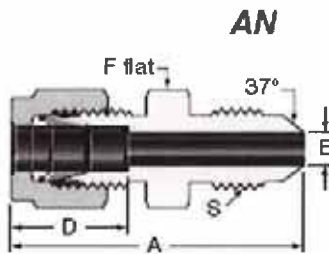

**AN**

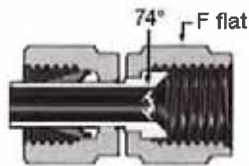

**AN Female**

(For dimensions see catalog.)

THIS IS PART OF  
 CRM 0A21025-5

## Product Options:

The product options listed below affect pressure and/or temperature ratings shown in the above Summary Table, but in all cases the ratings are less than, or equal to, those shown in the table.

1. Bored-Through Fittings.
2. RP gaskets:
  - a. Copper
  - b. Nickel
  - c. PTFE
3. RS gaskets:
  - a. Metal-and-elastomer bonded
  - b. Non-bonded stainless steel
  - c. Copper
4. RG gaskets:
  - a. Copper
  - b. Nickel
  - c. PTFE
5. Sealant for tapered pipe threads (NPT and ISO-7):
  - a. Curable resin with PTFE
  - b. PTFE tape

Additional options that do not affect pressure and/or temperature ratings may be made available within the scope of this approval. Examples of these would include the following:

1. Special marking
2. Special cleaning
3. Wire drills
4. bulkhead configurations
5. Snubbers/frits and orifice plates
6. Equivalent metric or fractional hex sizes

All of the above options are within the scope of this approval.

## Quality System

The Swagelok Company quality system complies with the requirements of ISO 9001:2015. The Swagelok Company maintains BSI Certificate of Registration Number FM 01729, which applies to all locations listed on the Certificate.

## References

The product catalog does not represent the full scope of the registration but rather details some of the most common options.

- Gaugeable Tube Fittings and Adapter Fittings MS-01-140, Rev X
- Swagelok Tubing Data Sheet MS-01-107, Rev N

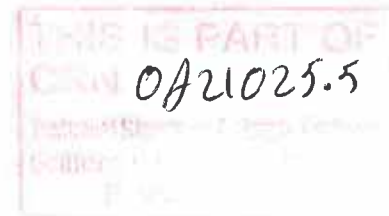

## Attachment A. Swagelok Manufacturing Locations

This document lists the Swagelok locations where end item or component level manufacturing activities take place.

Swagelok Company 29500 Solon Road Solon, Ohio 44139 USA	Swagelok Company (Falon 1) 348 Bishop Road Highland Heights, Ohio 44143 USA
Swagelok Company (Highland) 318 Bishop Road Highland Heights, Ohio 44143 USA	Swagelok Company (Falon 2) 358 Bishop Road Highland Heights, Ohio 44143 USA
Swagelok Company (OFC) 29495 F.A. Lennon Drive Solon, Ohio 44139 USA	Swagelok Company (HPF) 6050 Cochran Road Solon, Ohio 44139 USA
Swagelok Company (Atlantic) 26651 Curtiss Wright Parkway Willoughby Hills, Ohio 44092 USA	Swagelok Company (Snow Metal) 6060 Cochran Road Solon, Ohio 44139 USA
Swagelok Company (Micro) 26653 Curtiss Wright Parkway Willoughby Hills, Ohio 44092 USA	Swagelok Company (Alfred) 29500 Ambina Drive Solon, Ohio 44139
Swagelok Hose Services Company (SHSC) 29900 Solon Industrial Parkway Solon, Ohio 44139	Swagelok Company (Strongsville) 15400 Foltz Road Strongsville, Ohio 44119
Swagelok (China) Fluid System Technologies Ltd, Changshu Export Process Zone Changshu Economic Development Zone Changshu, Jiangshu 215513 China	Swagelok Company A.G. (European Technology Center) St. GallerstraBe 84 Lachen, Switzerland 8853 Switzerland
Swagelok Limited Ballafletcher Road Tromode IM4 4RA Isle of Man	

